

MaxaMizer

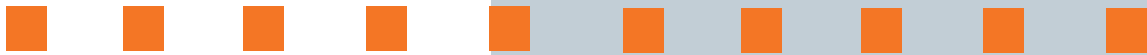

ACAT

TEL. 81 8354 8910
www.acatmexicana.com

Computer Controlled Spray Lubricating System

MaxaMizer

The Maxamizer is a computer controlled, low pressure airless spray system that dispenses lubricant from as many as twelve nozzles. A LSP computer controls the spraying of the lubricant and can be located remote from the dispensing manifold, and the nozzles can be located up to 8' away from the dispensing manifold. Ideal for large dies, transfer dies, roll formers and other types of metalforming equipment.



The MaxaMizer shown on a die in a straightside press. Many dies will go into the press, and most of the dies are different and require differing amounts of lubricant.

Precision Lubricating System that Increases Production, Improves Quality of Parts while Reducing Lubricant Consumption!

Airless Spray System

Eliminates mist fogging in the work area

Low Pressure System

Eliminates lubricant bouncing off of the part into surrounding area.

Remote Manifolds

Clean installation, minimizes tubing for easy clean installation, leaving the work area open for easy die adjustments and operator viewing.

Use on Big or Small Jobs

Systems for 4 to 12 Nozzles.

Selective Lubrication Each nozzle is individually programmed as to which cycle it dispenses on, when it dispenses during the cycle and for how long it dispenses.

Job Memory

Memorizes jobs for fast setups.

In-Die Nozzles

Reduces setup time, nozzles are always properly positioned to the stock and die.

The MaxaMizer allows the setup person to setup the lubricating of each die in a manner of minutes. The spray nozzles can be positioned with strong magnets and lined on both sides of the die. The nozzles are aimed at each area that has to be lubricated.

MaxaMizer controller allows the operator to quickly shut off nozzles that are not being used. The operator then has the ability to individually program each of the operating nozzles as to when they will spray and how much lubricant each nozzle will dispense during the cycle of the press. When the dies are changed, inactive nozzles may be repositioned and activated, and active nozzles can be deactivated until needed.

The MaxaMizer is the Right Choice for All Size Jobs

It is versatile, fast to setup and easy to program. When an application changes, the MaxaMizer can easily be reasigned to another job by just reprogramming the system to fit the new parameters.

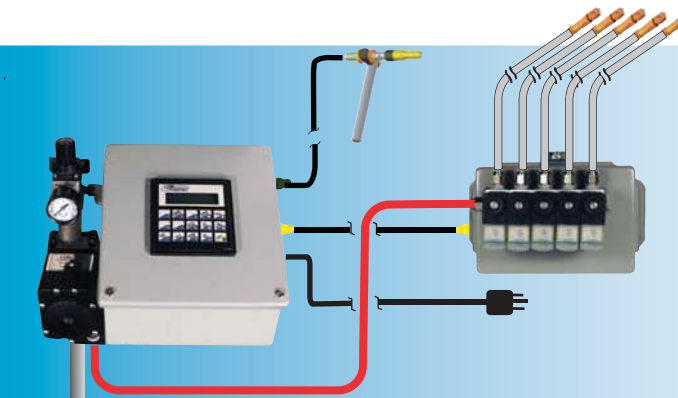

MX-1005

A Module system with 6 Nozzles from a single manifold. The Reservoir is located under the Module and the lubricant is moved to the Nozzles by the TransferPump. *Nozzles, Reservoir and Tubing are ordered Separately.*

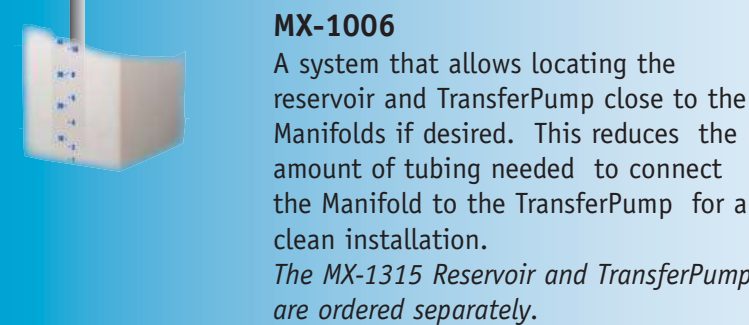

MX-1006

A system that allows locating the reservoir and TransferPump close to the Manifolds if desired. This reduces the amount of tubing needed to connect the Manifold to the TransferPump for a clean installation. *The MX-1315 Reservoir and TransferPump are ordered separately.*

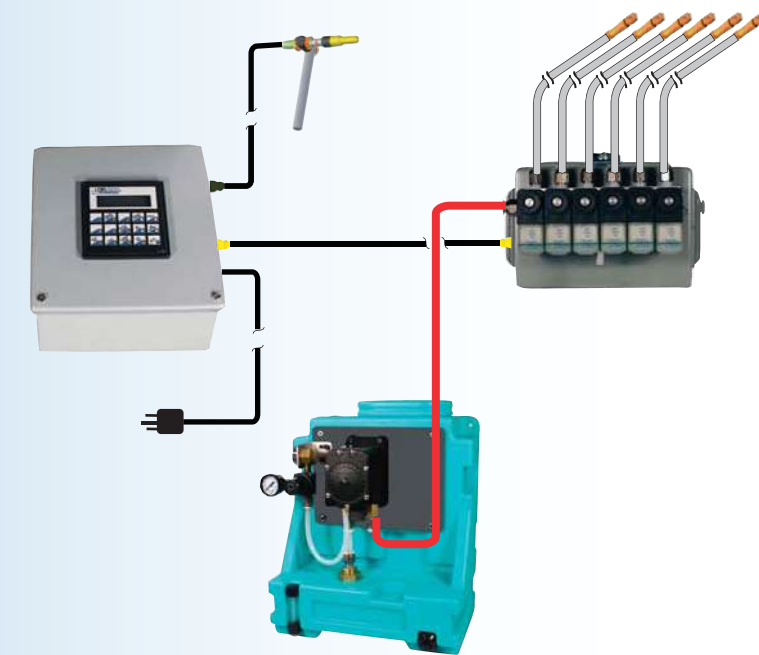

MX-2008

A module system with two 4 port Manifolds for 4 Nozzles each. The system is shown mounted on a PortaCart with a 12 gallon Reservoir for extra flexibility. Easily disconnected from one machine and moved to another as needed. *PortaCart, Reservoir, Nozzles and Tubing are ordered separately.*

State of the Art Lubricating System, Computer Controlled to reduce Lubricant Consumption Increase Die life.

Here's how the MaxaMizer works

The MaxaMizer is a low pressure spray lubricating system. A LSP computer controls the spray sequence on up to 12 nozzles. Each nozzle can be individually programmed as to which cycle of the press it will spray, how many actuations per cycle it will spray, when it will spray during a cycle and how long it can stay on during a cycle. A diaphragm pump supplies lubricant to the nozzles upon demand. A sensor identifies an object and sends a signal to the computer on each cycle of the press. The computer then opens the valves controlling each nozzle and allows lubricant to be forced to the nozzles in accordance with the sequence programmed into the MaxaMizer

Keypad
Input operating instructions for up to 12 nozzles. Each nozzle can be programmed independently for number of pulses, count, delay, on time and off time between pulses

Display Screen
Shows prompts and holds two lines of information

The LSP MaxaMizer Controller
A Programmable Controller provides independent programming of up to 12 Nozzles. Each nozzle can be independently programmed. Refer to Controller Specification on this page for full Specifications

Quick Change Connectors
Easily disconnected from the Controller, allowing Junction Box and nozzles to remain with dies for fast die set ups.

Proximity Sensor
On each cycle of the press the sensor receives a signal and sends it to the Controller. Upon receiving the signal it activates the valves as programmed. Includes 16' of cable and a swivel mounting bracket

Manifolds (Remote from the Controller)
Showing two 4 port Junction Boxes attached remotely to the Controller with 6' of Cable. Push/Pull Fittings allow for quick replacement of nozzle tubing.

5 and 6 port Manifolds also available.

Nozzles of Choice

- P-903**
3/16" tubing from Junction Box to Nozzle
- In-Die Nozzles**
Build Nozzle directly into the die
- Basic Nozzles**
Nozzle Assembly
See accessories for mounting devices
- FlexTubes**
Nozzles attached to a 12" Flexible Tube
- MagnaTubes**
Nozzles attached to a 12" Flexible hose mounted on a Magnet

Manifold Cable
Detachable Cable Connects to Manifold

110 - 220 V Cord
Three prong, six feet in length.

Optional 2nd Manifold
Can be used if additional nozzles are required. Used for systems with 8 or more nozzles.

MX-100X MaxaMizer



Proximity Sensor

- ◆ 12 Digital inputs including 2 inputs which can function as either high-speed counters, shaft encoders, frequency measurers or as normal digital inputs.
- ◆ 12 Transistor Outputs. First 2 outputs can function as high speed outputs.
- ◆ 2 Lines x 16 characters, STN LCD, LED backlight HMI Displays
- ◆ 110V/220V Standard input, converted to 24 VDC for operational use.
- ◆ Six foot Power Cord. Includes 16' of cable and swivel mounting bracket

Adapters to Accept

Proximity Sensor

- ◆ Provided with 16 foot quick disconnect cable.

Manifolds

- ◆ Provided in 4, 5 and 6 Port Outlets
- ◆ Includes with 6 foot quick disconnect cable.

Air Regulator
Regulates the air pressure to the pump, allowing a heavier spray or more pressure when needed.

Reservoirs
Heavy duty long chain polyethylene, opaque in color to give a clear view of the fluid volume.
MX-1312 12 Gallon Reservoir

MX-1901 Outlet Tubing
Carries lubricant from the TransferPump to the Manifold

TransferPump
Delivers up to three gallons per minute. Available either free standing over a reservoir as shown or on a Bracket holding the MaxaMizer Controller.

Comes w/6 feet of inlet tubing and 200 mesh filter.

MaxaMizer

There are twelve standard systems available in two configurations. Each configuration includes one or more manifolds capable of supporting a predetermined number of nozzles. Refer to page 7 to see the nozzle assemblies available for use with the MaxaMizer.

The MaxaMizer 1000 Series

TransferPump, Tubing, Nozzles and Accessories are not included.



Proximity Sensor
Includes 16 feet of cable



MX-1004 CompuSpray II Controller
with a four-port manifold

MX-1005 CompuSpray II Controller
with a five-port manifold



Manifold
Includes 6 feet of cable.

MX-1006 CompuSpray II Controller
with a six-port manifold

MX-1008 CompuSpray II Controller
with 2 four-port manifolds

MX-1010 CompuSpray II Controller
with 2 five-port manifolds

MX-1012 CompuSpray II Controller
with 2 six-port manifolds

The MaxaMizer 2000 Series

Tubing, Nozzles and Accessories are not included

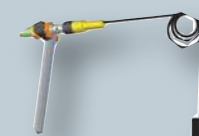

Proximity Sensor
Includes 16 feet of cable



MX-2004 CompuSpray II Controller
with a four-port manifold

MX-2005 CompuSpray II Controller
with a five-port manifold



Manifold
Includes 6 feet of cable.

MX-2006 CompuSpray II Controller
with a six-port manifold

MX-2008 CompuSpray II Controller
with 2 four-port manifolds

MX-2010 CompuSpray II Controller
with 2 five-port manifolds

MX-2012 CompuSpray II Controller
with 2 six-port manifolds

SPRAY NOZZLES & NOZZLE ACCESSORIES

Nozzles are available in different type assemblies and in an assortment of spray patterns. Accessory items can be added to aid in positioning the nozzles or making it more convenient

P-926 Nozzle Extender

An 11" Nozzle Extender that fits on the P-925 Nozzle Bracket for maneuverability. The use of this system eliminates all seals in the Nozzle system.

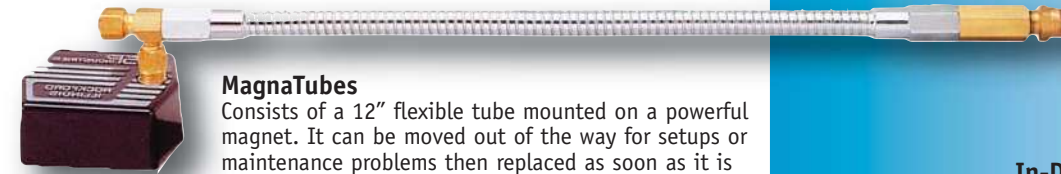

MagnaTubes

Consists of a 12" flexible tube mounted on a powerful magnet. It can be moved out of the way for setups or maintenance problems then replaced as soon as it is ready to resume production.



FlexTubes

Consists of a spray Nozzle attached to a 12" flexible tube with a mounting bracket at the other end. The mounting bracket is a 1/8 NPT stud. The FlexTube allows exact alignment of the spray to the work area.

Basic Nozzles

A nozzle of choice that can be permanently positioned or attached to Mounting Brackets.



P-925



P-925 Swivel Nozzle Bracket Holder

Nozzle Bracket Holder moves up and down on a 6" rod and rotates a full 360° for proper positioning of the nozzle. It holds the nozzle in a fixed position that does not wander. Adapts to a P-905 MagnaBase.



P-905

P-905 MagnaBase

Powerful Magnetic Base, accepts the P-926 Nozzle Extender. The MagnaBase offers easy placement, positioning or removal of the spray nozzle. It has a holding force of over 100 pounds.

In-Die Nozzles Reduce Setup Time

These are compact nozzle that allow them to be built into the dies with a minimal amount of machining. Since no check valves are needed it is highly unlikely that the nozzles will ever have to be removed for servicing. Building the Nozzles into the die reduces setup time and insures that the die will get the lubricant exactly where it is needed each time the die is run.



Quick Disconnects

Quick Disconnects: Male Plug Adapts to the die. Female Socket adapts to the going to the Manifold. Shutoffs in both ends prevent dripping when the Quick Disconnects are disengaged. When finished with a production run, disengage quick disconnects and change dies. Engage Quick Disconnects to new die and your lubrication setup is complete.

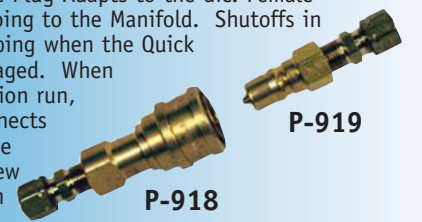

P-919

P-918

P-903 High Pressure Hose

The only non-metal tubing approved for use as a supply line to the nozzles. Flexible enough to afford the user easy positioning yet rigid enough to maintain a consistent spray pattern.

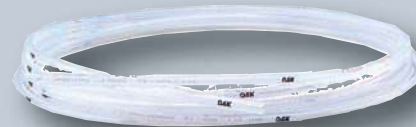

Type of Nozzle

Type of Spray Pattern Given by the Nozzle

Type of Nozzle	Type of Spray Pattern Given by the Nozzle					
	95° Fan	110° Fan	80° Fan	65° Fan	25° Fan	55° Drop
Basic Nozzles	MX-1200	MX-1201	MX-1202	MX-1203	MX-1205	MX-1207
Nozzles w/FlexTube	MX-1210	MX-1211	MX-1212	MX-1213	MX-1215	MX-1217
Nozzle w/FlexTube & Nozzle	MX-1220	MX-1221	MX-1222	MX-1223	MX-1225	MX-1227
In Die Nozzle	MX-1240	MX-1241	MX-1242	MX-1243	MX-1245	MX-1247
Nozzle w-1/8 NPT	MX-1240	MX-1241	MX-1242	MX-1243	MX-1245	MX-1247

MX-1207 Drop/Stream Nozzle

A Nozzle designed to dispense lubricant with pin point accuracy. Perfect for punches, flying cutoffs, assembly applications and more.



Accessories



MX-1901



MX-1902

Barb Fitting

MX-1901 1/8NPT x 1/2" barb connects to TransferPump
 MX-1902 1/4NPT x 1/2" barb connects to manifold



Proximity Sensor Cable Extenders Allows Proximity Sensor to be moved an extended distance from the Controller.
 MX-1350 10' Extender Cord
 MX-1351 15' Extender Cord



Reinforced Fluid Tubing From TransferPump to Manifold
 MX-1901 5/8 Polyvinyl Braided Tubing



Manifold Cable Extenders Allows Proximity Sensor to be moved an extended distance from the Controller. Complete with Quick Disconnect Fittings
 MX-1301 6' Extender Cord
 MX-1303 15' Extender Cord
 MX-1305 60' Extender Cord



MX-1315 15-Gallon Reservoir with TransferPump and Filter-Regulator-Guage



MX-1330 PortaCart

A portable cart to carry the MaxaMizer-2000 and a 12 gallon Reservoir. *Does not include 12 Gallon Reservoir..*

MX-1312 Reservoir

A heavy duty 12 gallon reservoir made from a long chain polyethylene. Opaque in color, gives a clear view of the fluid level.

Dimensional Drawings & Specifications

Manifolds MX-1124, MX-1125 & MX-1126

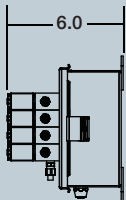
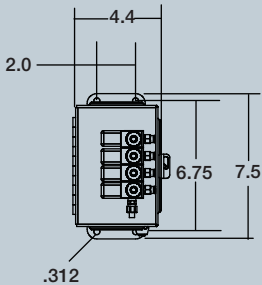

MaxaMizer-II CONTROLLER:

MX-1004, MX-1005, MX-1006, MX1008, MX-1010 & MX-1012

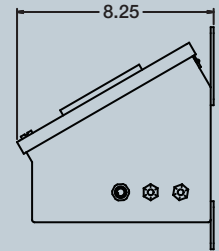
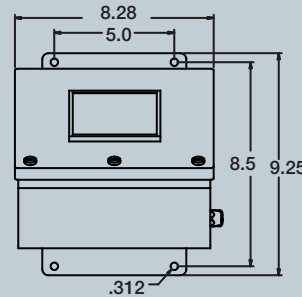

MaxaMizer-II CONTROLLER Mounted on a Plate:

MX-2004, MX-2005, MX-2006, MX2008, MX-2010 & MX-2012

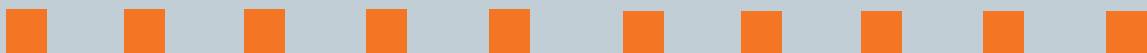
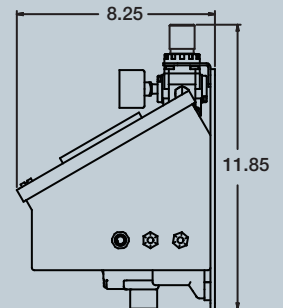
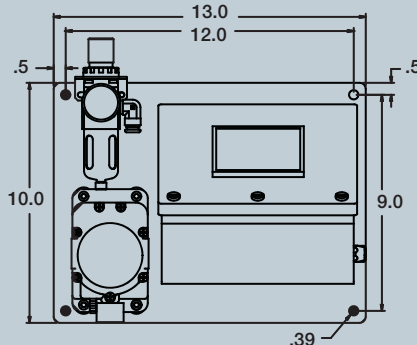

ACAT MEXICANA S.A. DE C.V.

Avenida Regio Parque #200, Regio Parque Industrial, Apodaca N.L. C.P. 66633



www.acatmexicana.com



acat@acatmexicana.com



TEL. 81 8354 8910